

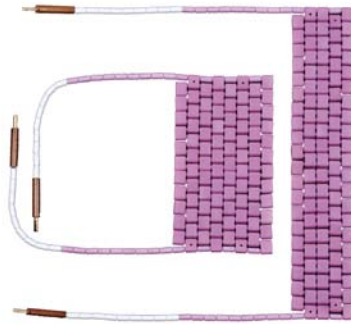

Delta Heat Services

Specialist in Heat Treatment



PRODUCT CATALOGUE

MENU

PLEASE CLICK HERE

**Specialist in the provision of
Heat Treatment Equipment, Services
and Thermal Systems**



Delta Heat Services was founded in 1997 and established their headquarters in Stellendam, The Netherlands. Delta Heat Services is a service aimed company, specialised in Industrial Heat Treatment. Due to our high level of knowledge, years of experience and technology Delta Heat Services delivered numerous high profile projects worldwide.

Delta Heat services operates worldwide to supply the demands of the global market. Our offices are based in The Netherlands – Stellendam (main office) and Elsloo (L), Belgium, Romania, Portugal, The Caribbean and Egypt. Out of these locations we provide the Heat Treatment market with services, sales and rental of equipment / consumables. All of our locations offer in-house (stationary furnaces), on-site services and rental/ sales.

Our field of activity includes refineries, power plants, assembly companies, shipyards, offshore, boiler / machine construction, among others, new built as well as maintenance and repair works. The equipment is continuously updated with the latest developments on Quality and Safety. All products are manufactured with ISO qualification, as detailed below

QUALITY ASSURANCE

The Company has gained and maintained a variety of approvals for its products and services to International standards from a variety of industrial sectors. The approvals for the supply of products and services include sectors within the Defence, Aerospace, Automotive, Nuclear Power Generation, Oil, Gas and Petrochemical Industries.

Delta Heat Services operates a quality management system that meets the requirements of -ISO 9001: 2000 and AS9100, Revision B.

Our catalogue contains the standard range of equipment we manufacture and a large selection of the spares and consumables most of which are ex stock.

We have the capacity to manufacture any special equipment you should require and have in depth knowledge of the heat treatment industry, so are able to produce equipment to operate in the harsh conditions encountered on sites world wide.

We are also able to supply spare parts for most of your existing heat treatment equipment, please contact us with your next enquiry, we would be delighted to quote you.

[RETURN TO MENU](#)

[< BACK](#)

[NEXT >](#)



Product Range		Pages
100000	50 KVA LOW VOLTAGE HEATING UNIT (TRANSFORMER)	1 - 4
	65 KVA LOW VOLTAGE HEATING UNIT (TRANSFORMER)	5 – 8
	3 PHASE DISTRIBUTION/CONTROL UNIT	9 – 10
<hr/>		
200000	TEMPERATURE CONTROL SYSTEM (PROGRAMMER)	11 – 12
<hr/>		
300000	TEMPERATURE MEASUREMENT (RECORDER)	13 – 14
	THERMOCOUPLE WELDING UNIT	15 – 16
<hr/>		
400000	CERAMIC PAD HEATING ELEMENTS	17 – 20
	CHANNEL HEATING ELEMENTS.....	21 – 22
	PREHEATER ELEMENTS	23 -24
<hr/>		
500000	LOW VOLTAGE AND MAINS CABLES	25
<hr/>		
600000	THERMAL INSULATION	26 -27 -29
<hr/>		
700000	EQUIPMENT SPARES :	
	LOW VOLTAGE HEATING UNIT (TRANSFORMER)	28
	TEMPERATURE CONTROL SYSTEM (PROGRAMMER)	29
	TEMPERATURE MEASUREMENT (RECORDER).....	30
	CABLE CONNECTORS	31
	CERAMIC PAD ELEMENT	32
	TANK TRACK ELEMENT	33
	CHANNEL HEATING ELEMENT	33
<hr/>		
800000	GENERAL SPARES.....	34
<hr/>		

50 KVA 6 CHANNEL LOW VOLTAGE HEATING UNIT WITH SET POINT CONTROL



The 50 kVA heat treatment unit has been robustly constructed to provide power to electrical resistance heaters at 60 volts, suitable for site and shop working.

The output from the unit is split into six individual heating circuits for temperature control. Each output circuit has 8.3 kW of power, which is sufficient capacity for three standard ceramic pads rated at 2.7 kW and connected in parallel. (See layout)

Each of the six circuits may be controlled individually using a combination of energy regulators and set-point temperature controllers – these are an integral part of the unit. Alternatively, fully automatic control is possible by switching in a programmer unit to gain control over rates of heating and cooling as well as soak conditions.



SPECIFICATION

Electrical rating	50 kVA, air natural.
Transformer	Air natural, Class H insulation
Dimensions	68cmWx70.5cmDx107cmH
Weight	312 kg
Casing	Carbon Steel, Stainless Steel or Heavy Duty Polyethylene
Primary Supply	380 - 76A/415 - 70A/440 - 65A, 3 phase
Output circuits	6 pair at rear, twistlock connectors
Protection	Overload – 3-phase MCCB. Over temperature sensor in windings – 3-phase MCCB with shunt trip.
Auxiliary Sockets	3 – sockets 110V ac, 5A (BS 4343) for instruments, etc.
Supply cable	5m primary provided, 16mm ² , 4-core, SY cable, (recessed angle location at rear).
Mobility	2 - swivel wheels, 160mm dia., 2 - fixed wheels, 160mm dia.
Lifting	Fork lift or webbing slings under casing.
Controls	6 circuits – each having 1 set point controller, 1 energy regulator, with auto/off/ manual switch and indicator lamp.
Programmer	Connect programmer unit (not supplied), via external socket at rear of unit.
Stock Ref	100001



Rear View

[RETURN TO MENU](#)

[← BACK](#)

[NEXT →](#)

50 KVA 6 CHANNEL LOW VOLTAGE HEATING UNIT WITH SET POINT CONTROL

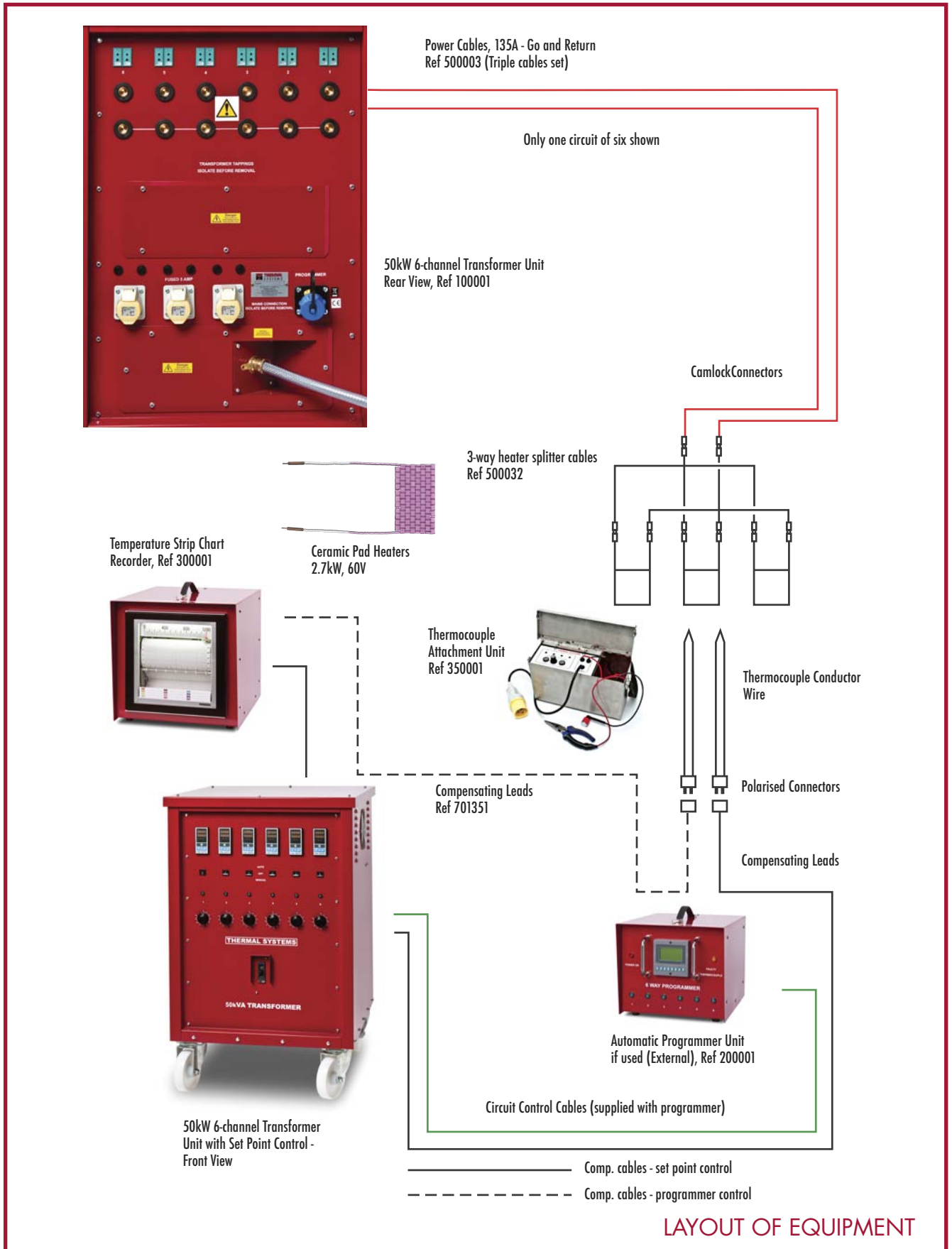

RETURN TO MENU

50 KVA 6 CHANNEL LOW VOLTAGE HEATING UNIT WITH INTEGRATED PROGRAMMER UNIT



The 50 kVA heat treatment unit has been robustly constructed to provide power to electrical resistance heaters at 60 volts, suitable for site and shop working.

The output from the unit is split into six individual heating circuits for temperature control. Each output circuit has 8.3 kW of power, which is sufficient capacity for three standard ceramic pads rated at 2.7 kW and connected in parallel. (See layout)

Each of the six circuits may be controlled collectively using a fully automatic temperature programmer – this is an integral part of the unit. The fully automatic programmer unit permits control over rates of heating and cooling as well as soak conditions. Each circuit may be controlled individually at a set point.

SPECIFICATION

Electrical rating	50 kVA, air natural.
Transformer	Air natural, Class H insulation
Dimensions	68cmWx70.5cmDx107cmH
Weight	312 kg
Casing	Carbon Steel, Stainless Steel or Heavy Duty Polyethylene
Primary Supply	380 - 76A/415 - 70A/440 - 65A, 3 phase
Output circuits	6 pair at rear, twistlock connectors
Protection	Overload – 3-phase MCCB. Over temperature sensor in windings – 3-phase MCCB with shunt trip.
Auxiliary Sockets	3 – sockets 110V ac, 5A (BS 4343) for instruments, etc.
Supply cable	5m primary provided, 16mm ² , 4-core, SY cable, (recessed angle location at rear).
Mobility	2 - swivel wheels, 160mm dia., 2-fixed wheels, 160mm dia.
Lifting	Fork lift or webbing slings under casing.
Controls	Fully automatic control for 6 channels.
Programmer	P256 programmer unit is an integrated feature of the unit.
Stock Ref	100002



[RETURN TO MENU](#)

[← BACK](#)

[NEXT →](#)

50 KVA 6 CHANNEL LOW VOLTAGE HEATING UNIT WITH INTEGRATED PROGRAMMER UNIT

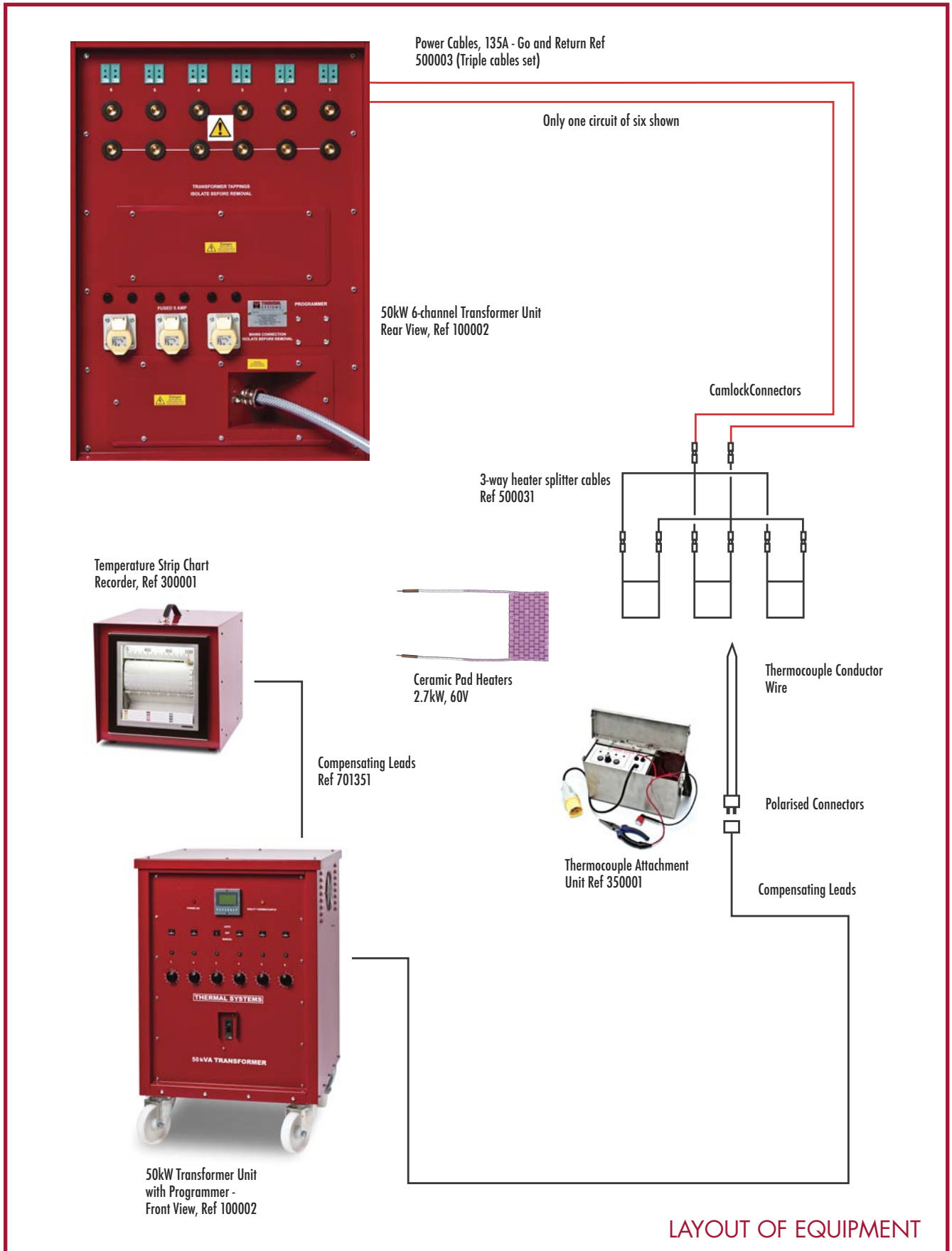

[RETURN TO MENU](#)

65 KVA 6 CHANNEL LOW VOLTAGE HEATING UNIT WITH SET POINT CONTROL



The 65 kVA heat treatment unit has been robustly constructed to provide power to electrical resistance heaters at 60 volts, suitable for site and shop working.

The output from the unit is split into six individual heating circuits for temperature control. Each output circuit has 10.8 kW of power, which is sufficient capacity for four standard ceramic pads rated at 2.7 kW and connected in parallel. (See layout)

Each of the six circuits may be controlled individually using a combination of energy regulators and set-point temperature controllers – these are an integral part of the unit. Alternatively, fully automatic control is possible by switching in a programmer unit to gain control over rates of heating and cooling as well as soak conditions.



SPECIFICATION

Electrical rating	65 kVA, air natural.
Transformer	Air natural, Class H insulation
Dimensions	68cmWx70.5cmDx107cmH
Weight	450 kg
Casing	Carbon Steel, Stainless Steel or Heavy Duty Polyethylene
Primary Supply	380V - 99A/415V - 90A/440V - 85A, 3 phase
Output circuits	6 pair at rear, twistlock connectors
Protection	Overload – 3-phase MCCB. Over temperature sensor in windings – 3-phase MCCB with shunt trip.
Auxiliary Sockets	3 – sockets 110V ac, 5A (BS 4343) for instruments, etc.
Supply cable	5m primary provided, 25mm ² , 4-core, SY cable, (recessed angle location at rear).
Mobility	2 - swivel wheels, 160mm dia., 2 - fixed wheels, 160mm dia.
Lifting	Fork lift or webbing slings under casing.
Controls	6 circuits – each having 1 set point controller, 1 energy regulator, with auto/off/ manual switch and indicator lamp.
Programmer	Connect programmer unit (not supplied), via external socket at rear of unit.
Stock Ref	100031



Rear View

[RETURN TO MENU](#)

[< BACK](#)

[NEXT >](#)

65 KVA 6 CHANNEL LOW VOLTAGE HEATING UNIT WITH SET POINT CONTROL

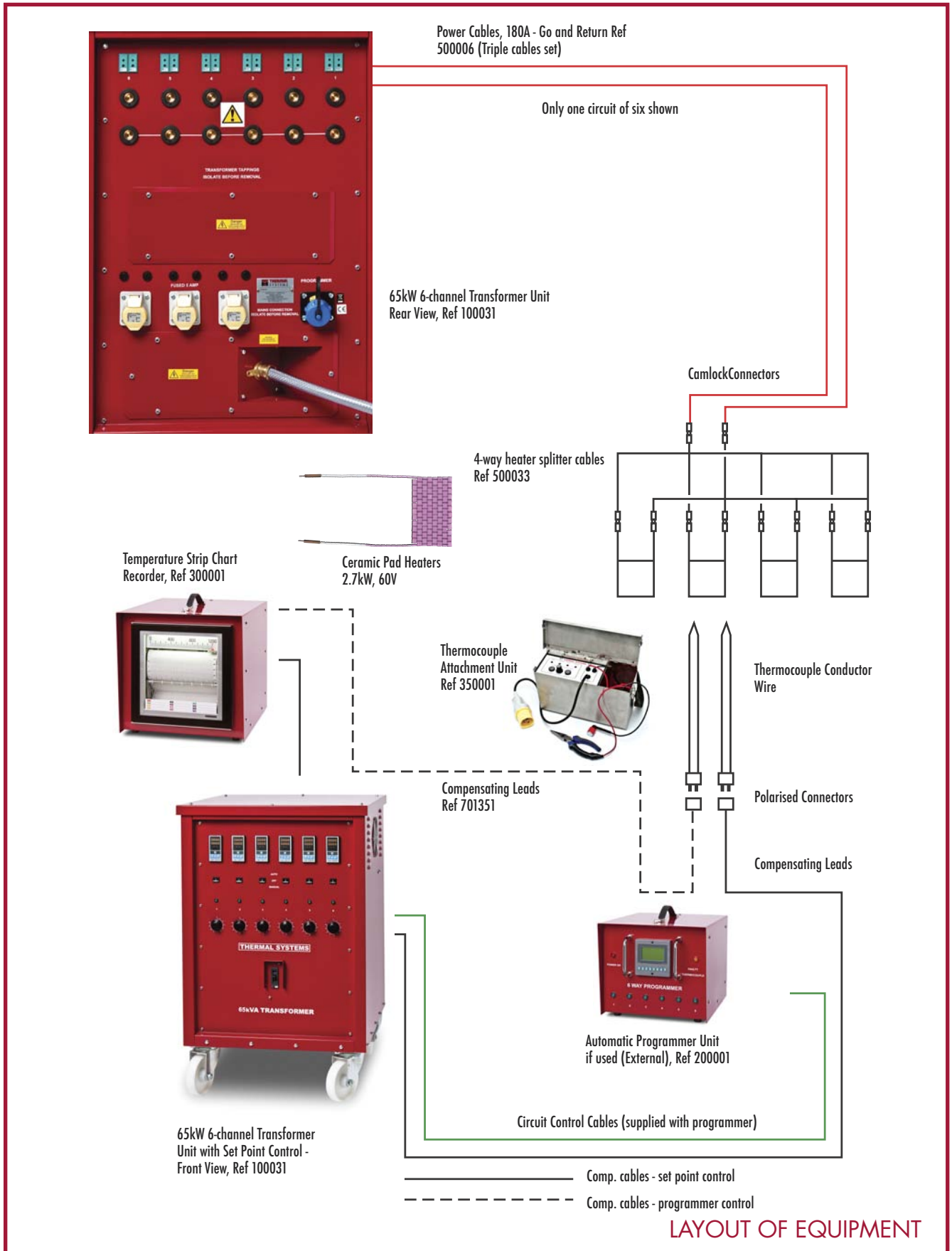

RETURN TO MENU

65 KVA 6 CHANNEL LOW VOLTAGE HEATING UNIT WITH INTEGRATED PROGRAMMER UNIT



The 65 kVA heat treatment unit has been robustly constructed to provide power to electrical resistance heaters at 60 volts, suitable for site and shop working.

The output from the unit is split into six individual heating circuits for temperature control. Each output circuit has 10.8 kW of power, which is sufficient capacity for four standard ceramic pads rated at 2.7 kW and connected in parallel. (See layout)

Each of the six circuits may be controlled collectively using a fully automatic temperature programmer – this is an integral part of the unit. The fully automatic programmer unit permits control over rates of heating and cooling as well as soak conditions. Each circuit may be controlled individually at a set point.

SPECIFICATION

Electrical rating	65 kVA, air natural.
Transformer	Air natural, Class H insulation
Dimensions	68cmWx70.5cmDx107cmH
Weight	450 kg
Casing	Carbon Steel, Stainless Steel or Heavy Duty Polyethylene
Primary Supply	380V - 99A/415V - 90A/440V - 85A, 3 phase
Output circuits	6 pair at rear, twistlock connectors
Protection	Overload – 3-phase MCCB. Over temperature sensor in windings – 3-phase MCCB with shunt trip.
Auxiliary Sockets	3 – sockets 110V ac, 5A (BS 4343) for instruments, etc.
Supply cable	5m primary provided, 25mm ² , 4-core, SY cable, (recessed angle location at rear).
Mobility	2 - swivel wheels, 160mm dia., 2-fixed wheels, 160mm dia.
Lifting	Fork lift or webbing slings under casing.
Controls	Fully automatic control for 6 channels.
Programmer	P256 programmer unit is an integrated feature of the unit.
Stock Ref	100032



Rear View

[RETURN TO MENU](#)

[< BACK](#)

[NEXT >](#)

65 KVA 6 CHANNEL LOW VOLTAGE HEATING UNIT WITH INTEGRATED PROGRAMMER UNIT

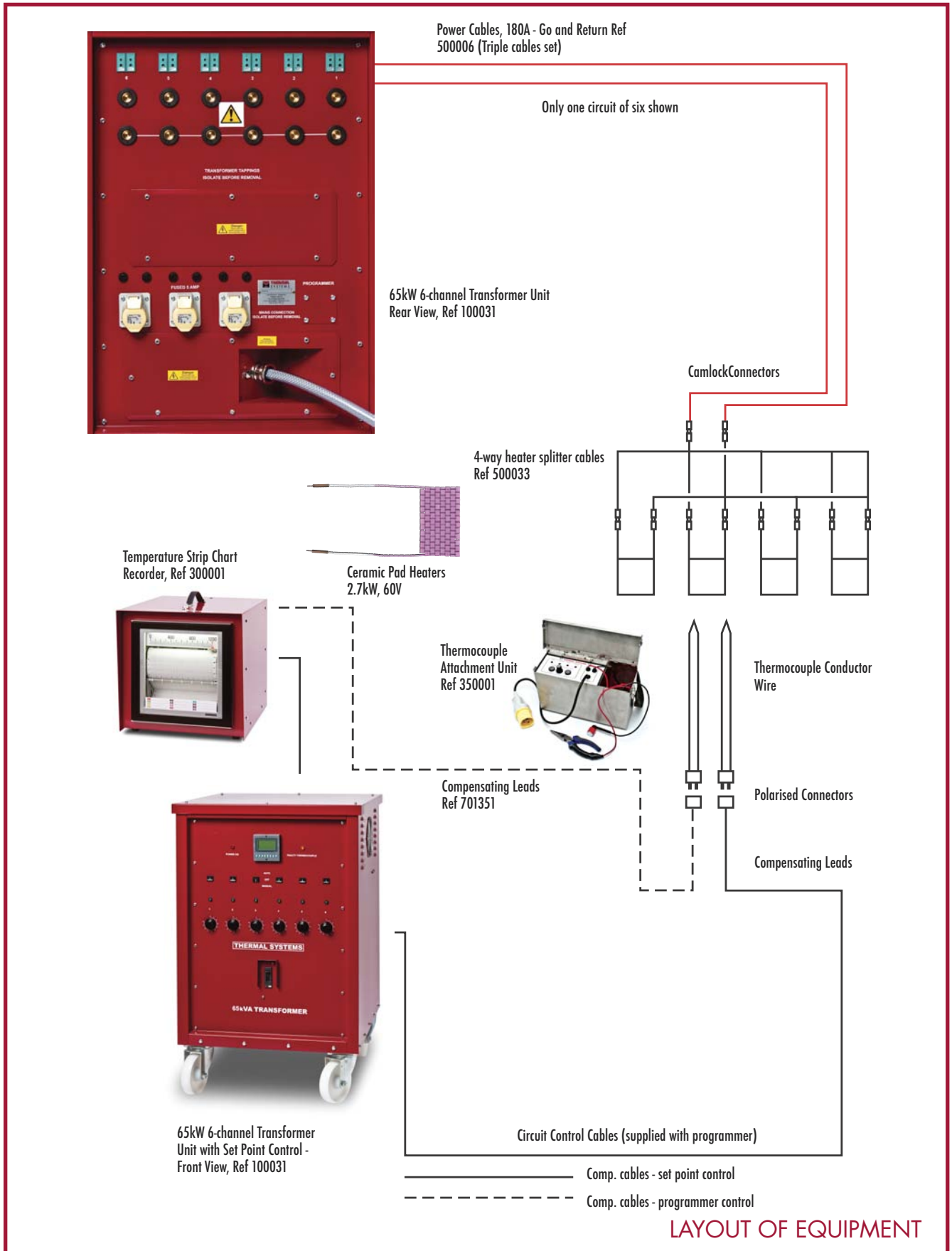

RETURN TO MENU

6 CHANNEL 3-PHASE DISTRIBUTION/ CONTROL UNIT



The 6 Channel 3-Phase Distribution/Control Unit has been robustly constructed to provide power to electrical resistance heaters connected to a 3-phase mains voltage electrical supply at 380/440V, 50/60 Hz. The unit is suitable for site and shop working.

The output from the unit is split into six individual heating circuits for temperature control. Each output circuit has a switching capacity of 63A, 3-phase, which is sufficient capacity for three standard channel heaters rated at 13kW, 240V connected in star. (See layout)

Each of the six circuits may be controlled individually using a combination of energy regulators and set-point temperature controllers – these are an integral part of the unit. Alternatively, fully automatic control is possible by switching in a programmer unit. Two heater designs suitable for use with the unit – the channel heater and the ceramic pad are shown below.

SPECIFICATION

Electrical rating	240 kW max., air natural.
Dimensions	97cmWx65cmDx95cmH
Weight	185 kg
Casing	Powder Coated Carbon Steel, Stainless Steel or Heavy Duty Polyethylene
Input Supply	380/440, 3 phase, 4 wire, 50Hz. Main switch rated at 450A
Output circuits	6- 3-phase, 4-wire circuits, 380/440V, 40kW each star connected.
Protection	Overload – each phase on each circuit protected with a 63A MCB.
Auxiliary Sockets	3 – sockets 110V ac, 5A (BS 4343) for instruments, etc.
Supply cable	Primary cable not supplied.
Mobility	2 - swivel wheels, 160mm dia., 2- fixed wheels, 160mm dia.
Lifting	Fork lift or webbing slings under casing. Integral handle on each side of unit.
Controls	6 circuits – each having 1 energy regulator, one set-point controller and indicator lamp.
Programmer	Connect remote programmer unit (not supplied), via external multipin plug at rear of unit.
Stock Ref	100541

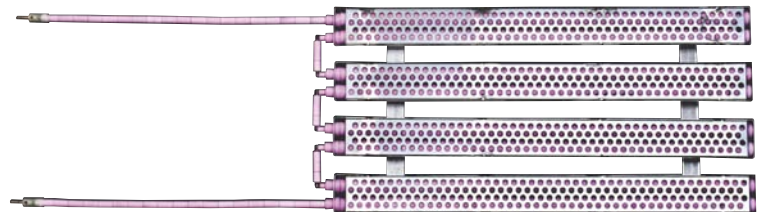

Channel Heater, 13kW, 240V

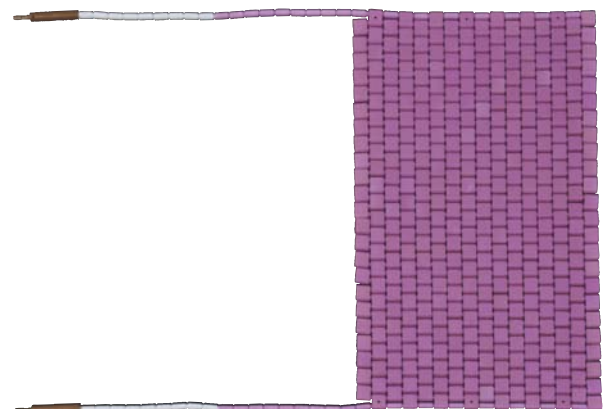

Ceramic Pad Heater, 10.8kW, 240V

[RETURN TO MENU](#)

[← BACK](#)

[NEXT →](#)

6 CHANNEL 3-PHASE DISTRIBUTION/ CONTROL UNIT

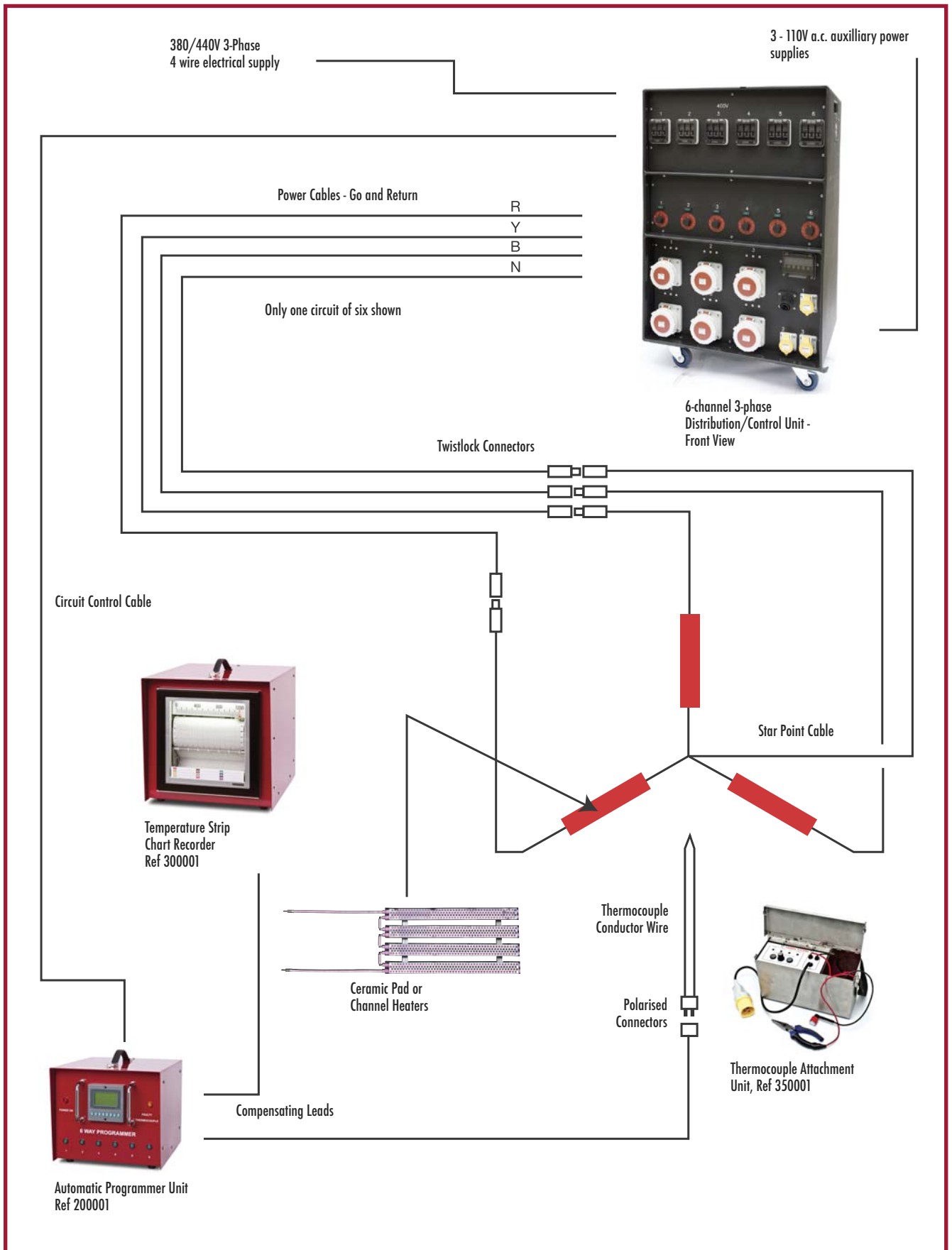

RETURN TO MENU



TEMPERATURE CONTROL SYSTEM

INTRODUCTION

Accurate and reliable temperature control is an essential part of heat treatment processes. Delta Heat Services has selected wellproven automatic temperature programmer units to address this critical requirement. It is vital that temperature control, like temperature measurement, is subject to the same close attention given to all aspects of the heating system – including heater and circuit layout, temperature-recording instrumentation, the specification and attachment of the thermocouple, the correct interlinking compensating or extension leads and their interconnection.

Heat treatments undertaken under site conditions or in workshops must utilise equipment that is convenient, robust and portable. Delta Heat Services offer equipment and consumables that meet these requirements – the diagram overleaf illustrates the layout for the temperature programming system.

THE TEMPERATURE PROGRAMMERS

Two of the temperature control programmers offered by Delta Heat Services are–

- The P256 unit offers the same facilities as the P167 programmer with some more sophisticated options. For example, this unit has an automatic hold feature should the permitted temperature tolerances be exceeded. It also has a facility to 'chain' with other P256 units so permitting the interlinking with the control on other transformer units.
- The P167 6-channel unit which is the simpler of the two, having a facility to preset the three primary segments of the PWHT process. These are – the rate of heating above a start temperature, soak temperature and time and rate of cooling down to an end temperature.

The programmers may be housed within a rugged steel casing or integrated within the heat treatment transformer. Rear polarised socket connections are fitted for the widely used Type K thermocouple to compensating lead connections. A flying lead is also fitted to the rear of the case for the 110V AC input power from the heat treatment transformer.



PROGRAMMER SPECIFICATION – P256

Overall dimensions	29cm W x 43cm H x 26cm L
Weight (cased)	8 kg
No. of control channels	6
Display	Graphic LCD panel, 128x64 pixel
Buttons	8-blue/green silicone rubber
Input Voltage	95-253V rms., 48/62 Hz
Types of thermocouple	Type K (standard)
Units	°C or °F: hours
Resolution	0.1°C measurement, 1°C display
Cycle time	20 seconds
Hold Band	1, 2 or 3 times proportional band
Hold Type	Below only or above/below
Set Point	Manual or auto
Manual set point	0-1200°C in 1°C increments
Heating rate	0-1000°C/hour in 1°C increments
Soak temperature	0-1200°C in 1°C increments
Soak time	1-100 hours in 0.1 hr increments
Cooling rate	0-1000°C/hour in 1°C increments
Ambient conditions	0°C to +60°C, 5-95% rel. humidity
Stock Ref	200001

The P256 programmer has a number of useful additional facilities–

1. The unit detects a thermocouple open circuit. This is treated as over the set temperature range and fails safely 'circuit off'.
2. In manual mode, the set point only can be preset.
3. Loss of supply usually results in a temperature drop. When power is restored, temperature ramps up from hottest channel to the set profile.
4. Serial communication between other P256 programmers or to a PC.

[RETURN TO MENU](#)



TEMPERATURE CONTROL SYSTEM

PROGRAMMER SPECIFICATION – P167



Overall dimensions	27cm W x 15cm H x 42cm L
Weight (cased)	8 kg
No. of control channels	6
Display	LED, 7-segment
Input Voltage	115 OR 230V A.C., 50/60 Hz
Types of thermocouple	Type K (standard)
Units	°C: hours & minutes
Resolution	0.1°C measurement, 1°C display
Proportional band	±10°C, ±20°C or ±30°C
Cycle time	25 seconds
Set point	0-1200°C in 1°C increments
Heating rate	0-999°C/hour in 1°C increments
Soak temperature	0-1200°C in 1°C increments
Soak time	1-100 hours in 0.1 hr increments
Cooling rate	0-999°C/hour in 1°C increments
Ambient conditions	0°C to +60°C, 5-95% rel. humidity
Ref. No	200011

ARRANGEMENT OF EQUIPMENT FOR TEMPERATURE CONTROL

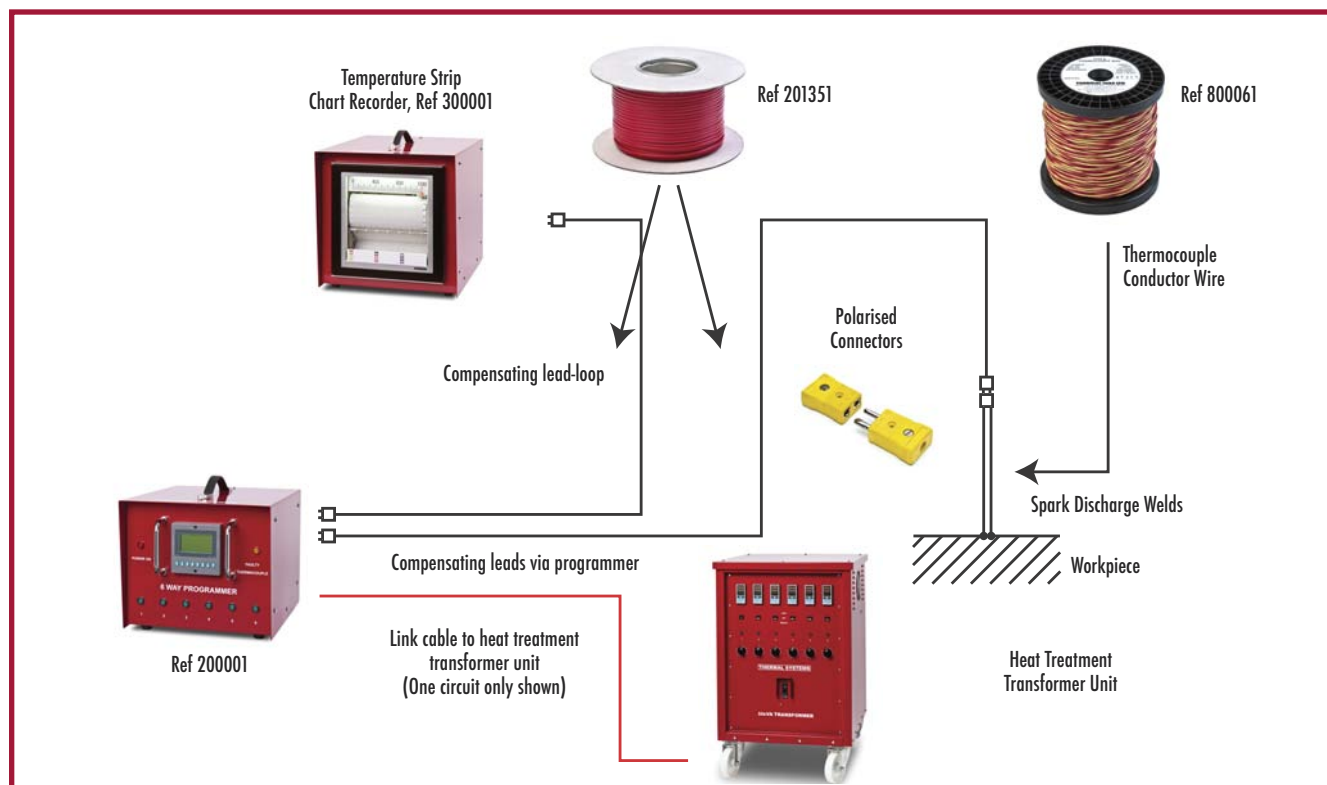

RETURN TO MENU

TEMPERATURE MEASUREMENT – ANALOGUE RECORDER



INTRODUCTION

Accurate temperature measurement is fundamental to successful heat treatment practice. This can only be achieved by attention to all aspects of the temperature measurement system and must include the temperature-recording instrumentation, the specification and attachment of the thermocouple, the correct compensating or extension leads and their inter-connection.

Heat treatment processes carried out under site conditions or in workshops must utilise equipment that is convenient, robust and portable. Delta Heat Services offer equipment and consumables that meet these requirements.

TEMPERATURE RECORDER

The 12-channel analogue Chino temperature recorder opposite has been selected as ideal for the rigours of site heat treatment. The recorder design is potentiometric, self-compensating for ambient temperature and operates over the temperature range 0-1200°C

The recorder is housed within a rugged steel casing and is fitted with rear polarised socket connections for the widely used Type K thermocouple to compensating lead connections, to prevent reading errors. A flying lead is also fitted to the rear of the case to for the 110V AC input power from the heat treatment transformer.



Stock Ref. 800159

The internal power supply and chart drive switches are readily accessible. The chart drive can be varied to suit the heat treatment specification or conditions. The temperature charts extend for up to 400 hours for a chart speed of 50mm/hour. The scale and chart are illuminated.



ANALOGUE RECORDER SPECIFICATION

Model EH100-12. Ref No 300001

Overall dimensions	360mm W x 360mm H x 445mm L
Weight (cased)	22.5 kg
Scale length	180mm
Accuracy	0.6% input span
Balancing time	2 seconds
Input Voltage	100-240V A.C., 50/60 Hz
Types of thermocouple	Type K (standard)
Chart dimensions	200mm W x 20 m fanfold
Channels	12
Stamping interval	6 seconds (50 Hz); 5 seconds (60Hz)
Stamping System	Dot printing
Ambient temperature	-10°C to +50°C

RECORDER SPARES Ref No 300001

Stock Ref	Description
SPARES	
700401	0/1200°C Temperature chart
730403	Print wheel
730407	Chart spindle
730420	Drive wire
730402	Ink pad case
730423	Lamp
730401	Inks (12 colour)
ANCILLIARY EQUIPMENT	
800159	Calibration unit

[RETURN TO MENU](#)

[< BACK](#)

[NEXT >](#)

TEMPERATURE MEASUREMENT – DIGITAL RECORDER



INTRODUCTION

Delta Heat Services offers a digital recorder as an alternative to the analogue recorder overleaf.

The digital recorder has a number of useful features to supplement the robust features of the analogue version and these follow. The hybrid recorder is a 180mm multi-point type having 12 channels and provides a simultaneous display of multi-channel data, universal sensor input with alarm display and printing options. Packages for data processing for use with the recorder are available.

TEMPERATURE RECORDER

The 12-channel digital Chino temperature recorder opposite has also been selected as ideal for the rigours of site heat treatment. It has a number of useful features–

- Simultaneous display of multipoint data which is readily available.
- Its universal input permits 56 options – 10 DC voltage ranges, 35 thermocouple ranges and 11 resistance thermometer ranges. These may be programmed for individual channels.
- Clear trend and digital printing which uses a cassette type wire-dotting 6-colour ink ribbon.
- Chart illumination convenient for reading data at low ambient light levels.
- A supplementary software packages are available for data processing using a PC. A separate software package is also available that allows inputs and printing through a PC.

An optional communications interface is available for configuration with a PC.

The recorder is housed within a rugged steel casing and is fitted with rear polarised socket connections for the widely used Type K thermocouple to compensating lead connections, to prevent reading errors. A flying lead is also fitted to the rear of the case to for the 110V AC input power from the heat treatment transformer.



DIGITAL RECORDER SPECIFICATION

Model AH3725-N00. Ref No 300015

Overall dimensions	360mm W x 360mm H x 445mm L
Weight (cased)	18.5 kg
Scale length	180mm
Accuracy	±0.1% input span
Balancing time	2 seconds
Input Voltage	100-240V A.C., 50/60 Hz
Types of thermocouple	Selectable, set for Type K
Chart dimensions	200mm W x 20 m fanfold
Channels	12
Stamping interval	10 seconds
Stamping System	Dot printing
Ambient temperature	0°C to +40°C

RECORDER SPARES Ref No 300015

Stock Ref	Description
SPARES	
700402	0/1200°C Temperature chart
730601	Ink ribbon cassette
730602	Chart cassette
730603	Drive cord
730604	Door
ANCILLIARY EQUIPMENT	
800159	Calibration unit

[RETURN TO MENU](#)



THERMOCOUPLE WELDING UNITS



Stock Ref. 350001

	Standard Unit	Mini Unit
Dimensions	180Hx289Wx95mmD	157Hx95Wx45mmD
Weight	4kg	0.74kg
Max operating voltage	60V	100V
Charge Voltage	110 or 240V a.c.	6V
Discharge energy	20-40 Joules	20-50 Joules
T/couple types	Type K,	Type K,
Standard Wire size	0.711mm dia	0.711mm dia
Approx no of applications before re-charge	450	250
Stock Ref	350001	350020

OPERATION OF THERMOCOUPLE WELDING UNITS

- Remove loose scale or rust by wire brushing or other suitable means.
- Dress a small area no more than 100mm from attachment point to bright metal for return magnet.
- Set the output to approx 80% of maximum output.
- Push back insulation on thermocouples conductor wire to expose 5mm of bare wire.
- Grip conductor wire 4mm from wire end with pliers & firmly touch wire end to attachment point at 90°
- Press discharge button
- Gently bend wire through 90° 3-4mm above surface. If weld is sound, repeat for second conductor wire. Welds to be approx 5mm apart.

THERMOCOUPLE ATTACHMENT

Accurate temperature measurement is ensured by the attachment of thermocouple conductor wires directly to the metal surface by a spark discharge welding system. Accordingly, the metal surface becomes the hot junction of the thermocouple, so eliminating any inaccuracy associated with direct heat transfer from the heating source. After the wires are removed from the metal surface, it is usually necessary only to lightly dress the local area.

The standard unit is operated from a rechargeable battery – several hundred welds can be made before a re-charge becomes necessary using the 110V AC connection to the heat treatment transformer. The unit operates at a safe low voltage.



Stock Ref. 350020

The Mini welding unit is significantly lighter and smaller than the standard unit and therefore is more portable. The unit is therefore particularly useful in locations where access is poor.

The unit may be worn on a belt so permitting the operator freedom for access and manipulation in confined spaces.

Unlike the standard unit the smaller mini unit is powered by AA batteries and therefore has a lower number of applications before recharge.

[RETURN TO MENU](#)

[< BACK](#)

[NEXT >](#)



THERMOCOUPLE ATTACHMENT WELD

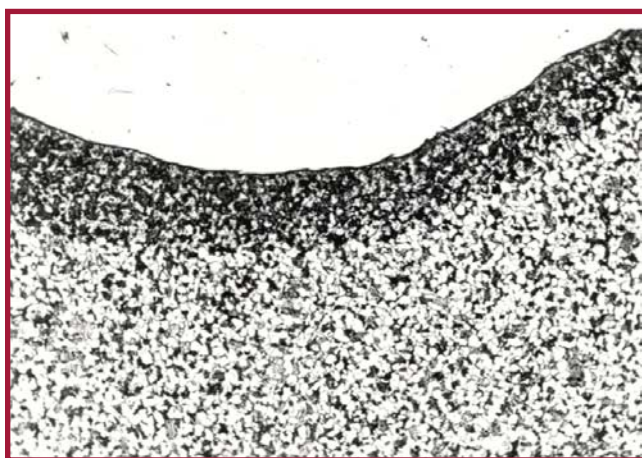

Section through Weld between Type K Conductor and Ferritic Steel Component.

Preheating for thermocouple attachment is not normally necessary. The typical depth of penetration of the weld is only in the order of 0.20mm and the associated heat affected zone in the parent metal extends by up to a further 0.10mm.

On completion of the heat treatment process, the thermocouple conductor wires can be readily removed and the area lightly dressed.

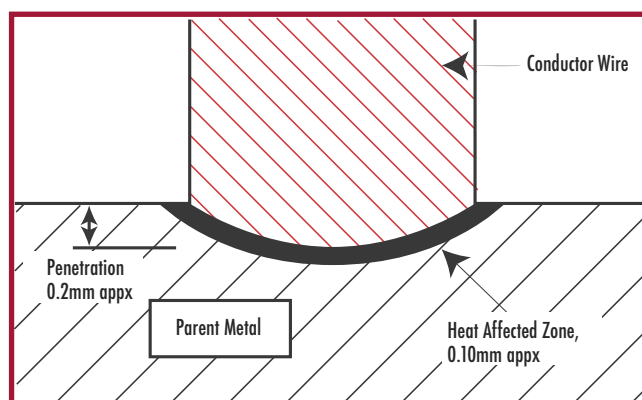

ARRANGEMENT OF EQUIPMENT FOR TEMPERATURE MEASUREMENT

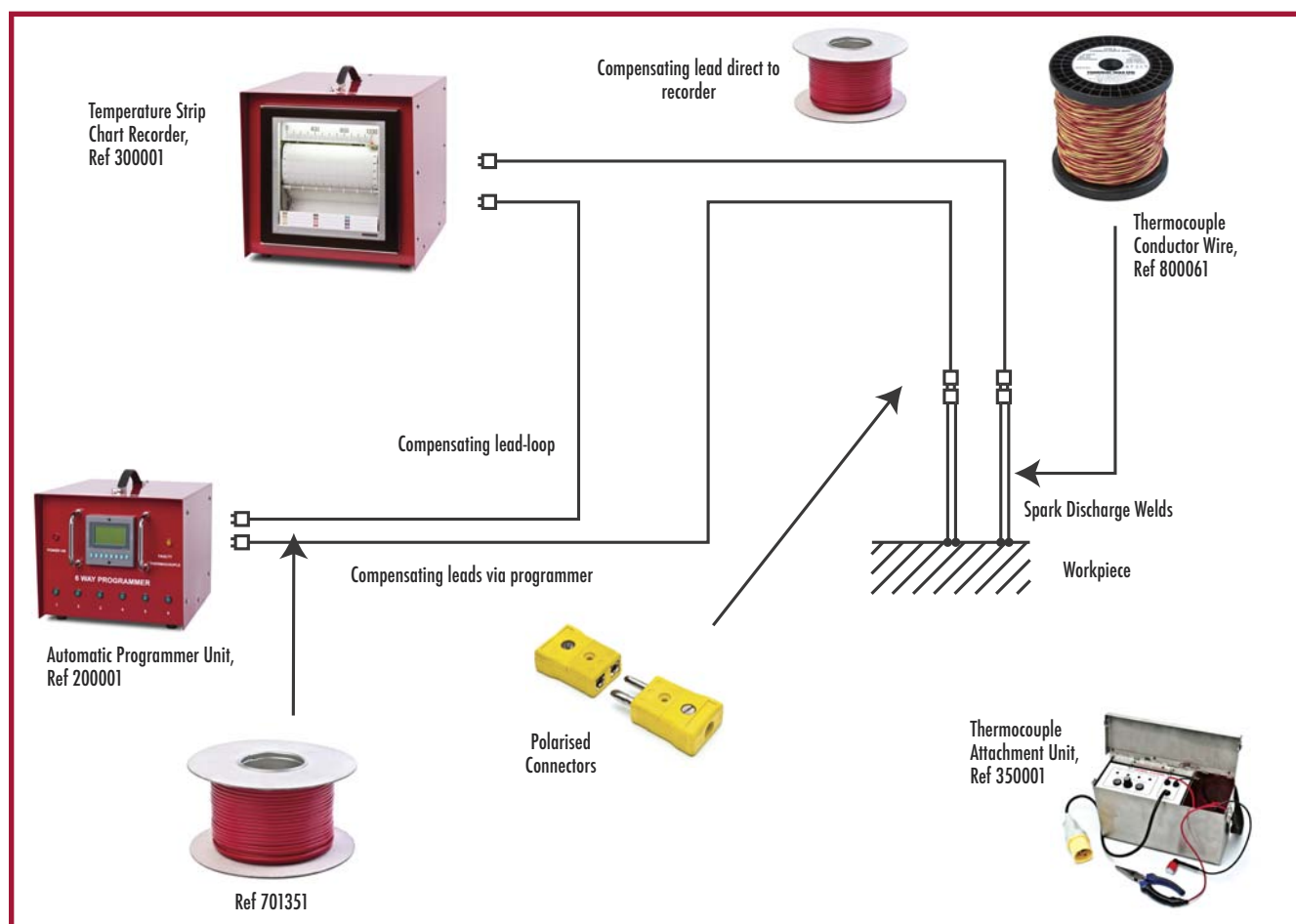

RETURN TO MENU



CERAMIC PAD HEATING ELEMENTS

INTRODUCTION

The ceramic pad is the workhorse of on-site heat treatment. In view of their flexibility, they may be applied flat or to curved surfaces. They are ideal for the preheat and PWHT of pipework butt welds.

As the design is modular they are suitable for a wide range of sizes and shapes.

DESIGN

The ceramic pad is manufactured from high alumina ceramic beads with a nickel-chromium flexible core wire serpentine within the beads. Nickel tails are welded to the core wire. The pads are flexible and suitable for heat treatment temperatures up to 1050°C. Temperatures above this value can be achieved by variation of the composition of the core wire.

Standard pads are supplied for a range of voltages up to 240V

APPLICATION

Standard 30V, 60V and 80V heaters should deliver a current of 45amps. Minimise secondary cable lengths. Standard 48V heaters should deliver a current of 52 amps. Check the current delivered.

Fit heater pad securely to component by banding or other suitable means and lock connectors fully home.

Avoid contaminants (grease, paint, oil etc) on the metal surface.

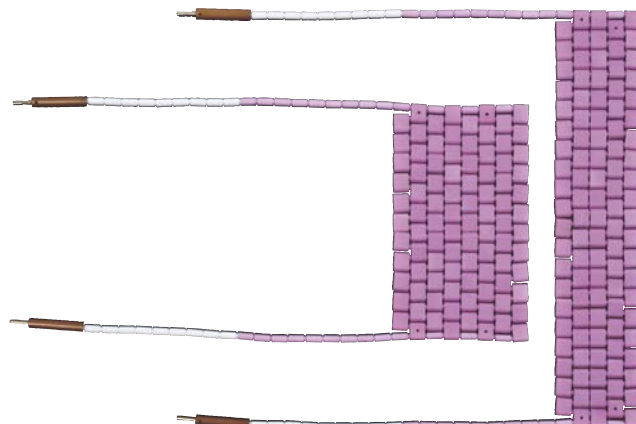
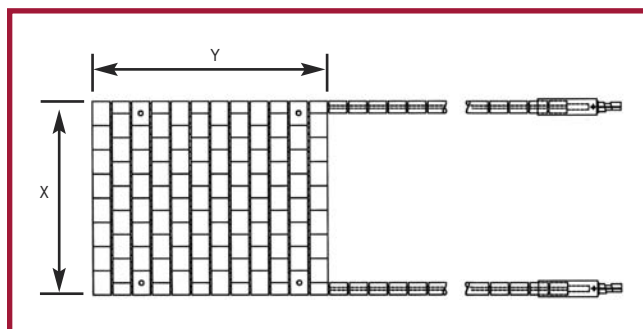

60V CERAMIC PADS

Stock Ref	X, Width,mm	Y, Length, mm	Volts	kW
400001	76	672	60	2.7
400002	102	504	60	2.7
400003	152	336	60	2.7
400004	203	252	60	2.7
400005	254	210	60	2.7
400006	305	168	60	2.7
400007	381	147	60	2.7
400008	406	126	60	2.7
400009	534	104	60	2.7
400010	610	84	60	2.7
400011	1220	42	60	2.7

48V CERAMIC PADS

Stock Ref	X, Width,mm	Y, Length, mm	Volts	kW
400091	76	672	48	2.5
400092	102	504	48	2.5
400093	152	336	48	2.5
400094	203	252	48	2.5
400095	254	210	48	2.5
400096	305	168	48	2.5
400097	381	147	48	2.5
400098	406	126	48	2.5
400099	534	104	48	2.5
400100	610	84	48	2.5
400101	1220	42	48	2.5

[RETURN TO MENU](#)



80V CERAMIC PAD HEATERS

APPLICATION

The use of heat treatment power sources giving a secondary output voltage of 80V is common in North America. Delta Heat Services therefore offers a range of standard ceramic pad heaters for use with 80V equipment.

All of the heaters deliver a current of approximately 45amps. Secondary cable lengths should be minimised to limit the reduction of secondary voltage at the heater. Check the current delivered.

Fit heater pad securely to component by banding or other suitable means and lock connectors fully home.

Avoid contaminants (grease, paint, oil etc) on the metal surface.

80V CERAMIC PADS

Ref No.	X, Width,mm	Y, Length, mm	Volts	kW
400031	76	924	80	3.7
400032	102	693	80	3.7
400033	152	462	80	3.7
400034	203	357	80	3.7
400035	254	294	80	3.7
400036	305	231	80	3.7
400037	381	189	80	3.7
400038	432	168	80	3.7
400039	534	147	80	3.7
400040	838	84	80	3.7
400041	1676	42	80	3.7

CERAMIC PAD HEATING ELEMENTS – COMPONENT PARTS

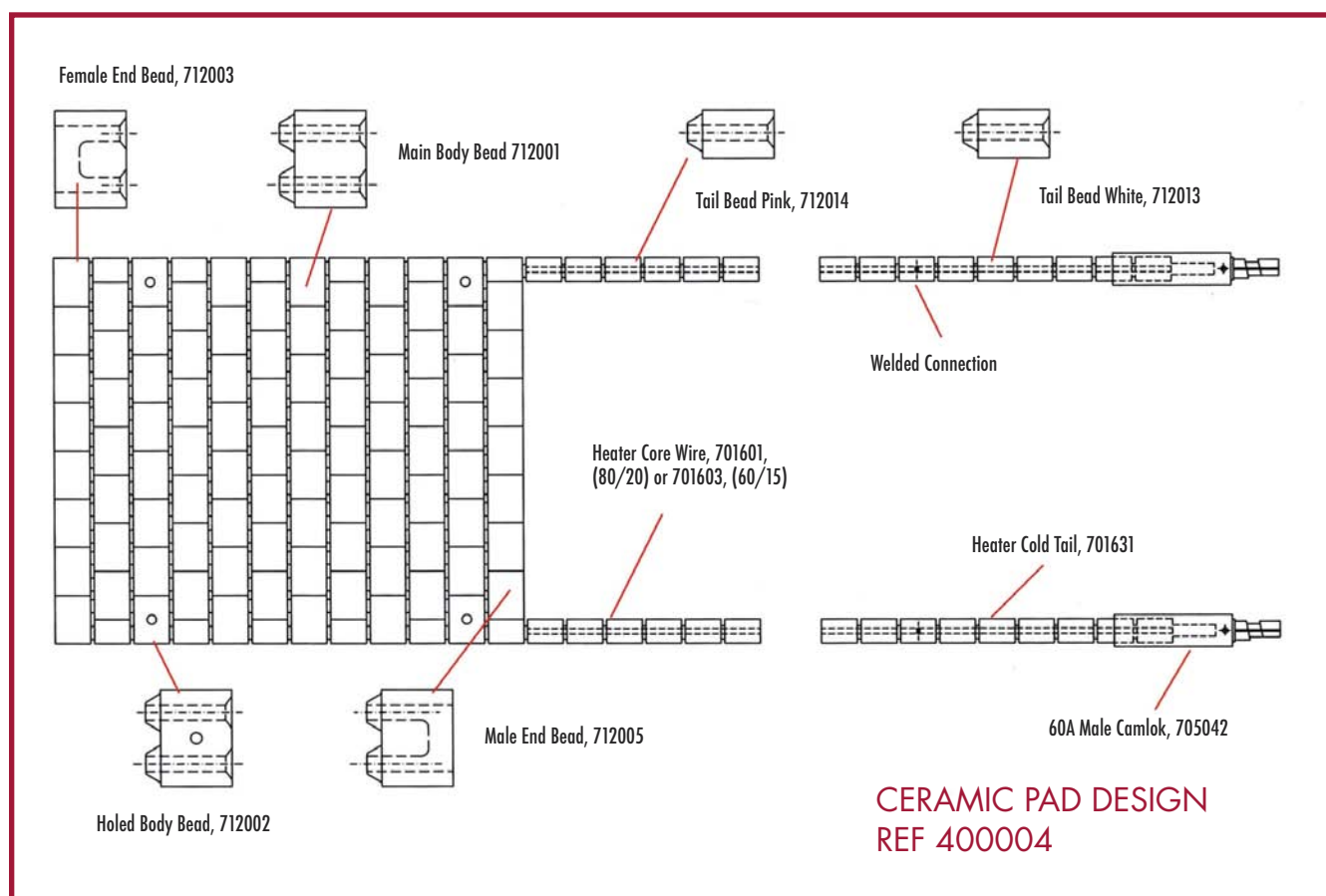

RETURN TO MENU



30V CERAMIC PAD HEATERS

APPLICATION

There are applications where the use of a pad smaller than the standard 60 V heater is useful. For example, a 30V pad may be used to advantage for the heat treatment of small-bore pipework butt welds. In addition, 30V pads may be used for application to pressure vessel surfaces near to nozzles or attachments – the 30V heaters may be applied locally to areas where unacceptably large spaces arise between larger pads.

The 30V pads may be connected in seriesed pairs to a 60V supply, subject to the pads performing a similar function. Alternatively they may be connected directly to a 30V supply, either individually or in groups connected in parallel.

30V CERAMIC PADS

Ref No.	X, Width,mm	Y, Length, mm	Volts	kW
400061	76	336	30	1.35
400062	102	252	30	1.35
400063	152	168	30	1.35
400064	203	126	30	1.35
400065	254	105	30	1.35
400066	305	84	30	1.35
400067	381	84	30	1.35
400068	406	63	30	1.35
400069	534	63	30	1.35
400070	610	42	30	1.35

SELECTED ARRANGEMENTS OF (60V) PAD HEATERS FOR PWHT OF PIPE BUTT WELDS IN CARBON & LOW ALLOY STEELS

NOMINAL DIAMETER – INCHES	WALL THICKNESS, mm					
	0-20	20-25	26-30	31-40	41-50	50-60
1	1 x 400001	—	—	—	—	—
2	1 x 400002	—	—	—	—	—
3	1 x 400004	—	—	—	* 2 bands of heater pads	
4	1 x 400005	—	—	—	—	—
6	2 x 400004	2 x 400004	—	—	—	—
8	2 x 400005	3 x 400003	3 x 400003	—	—	—
10	3 x 400004	4 x 400002	4 x 400002	6 x 400004 *	—	—
12	4 x 400003	4 x 400003	4 x 400003	8 x 400003 *	—	—
14	3 x 400005	4 x 400004	6 x 400002	6 x 400002	8 x 400004 *	—
16	8 x 400004 *	8 x 400004 *	8 x 400004 *	10.x 400003 *	10.x 400003 *	—
18	8 x 400005 *	8 x 400005 *	8 x 400005 *	10 x 400004 *	10 x 400004 *	—
20	10 x 400004 *	10 x 400004 *	10 x 400004 *	10 x 400004 *	12 x 400003 *	12 x 400003 *
24	10 x 400005 *	10 x 400005 *	12 x 400004 *	12 x 400004 *	12 x 400004 *	14 x 400003 *

[RETURN TO MENU](#)

[< BACK](#)

[NEXT >](#)



220/240V CERAMIC PAD HEATERS

APPLICATION

Localised heat treatment is often required after welding on circumferential welds or with the fitting or repair welding of nozzles/attachments to the shell.

It is sometimes an advantage to undertake the heat treatment by the application of ceramic pad heaters to the external surface of the shell. This is particularly so where internal access is restricted or where there is a necessity for internal welding and the preheat and PWHT arrangements can be common.

The use of larger pads can be useful under such circumstances, but special attention must be given to safety precautions and also to the freedom of the metal surface from contaminants.

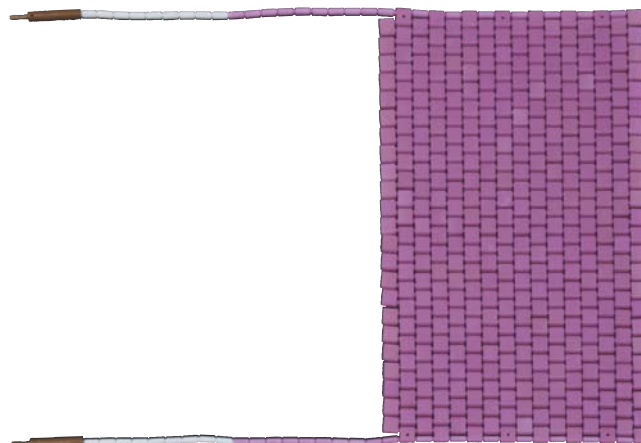

220/240V CERAMIC PADS

Ref No.	X, Width,mm	Y, Length, mm	Volts	kW
400121	330	672	240	10.8
400122	660	336	240	10.8
400131	330	610	220	9.9
400132	600	336	220	9.9

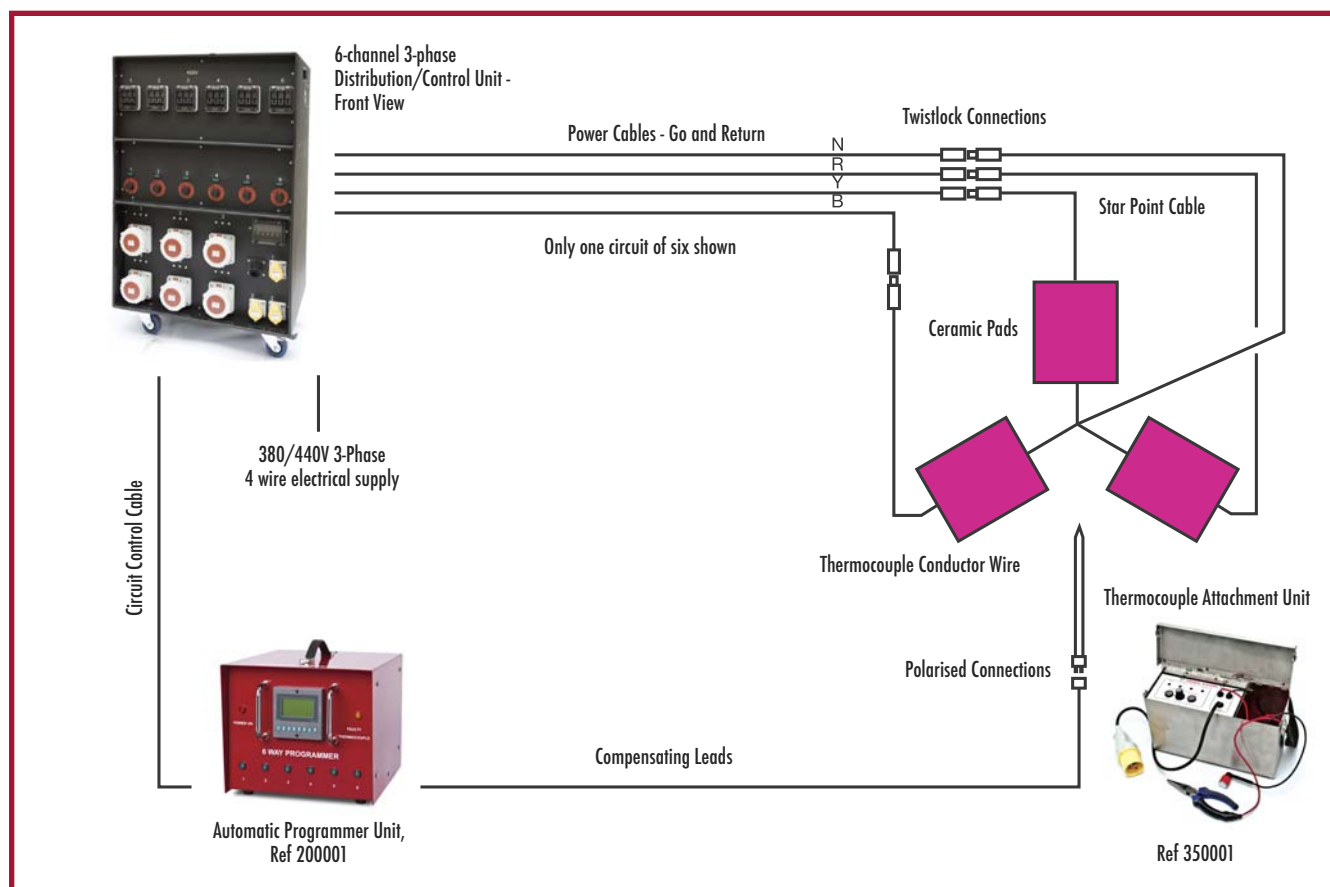

[RETURN TO MENU](#)



CHANNEL HEATING ELEMENTS

INTRODUCTION

The range of channel elements has been designed to provide modular heating units of a robust design suitable for connection to a mains or low voltage electrical supply.

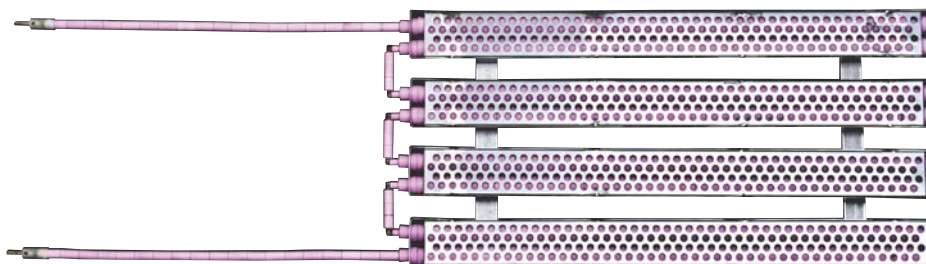

The heaters are portable and solid and are suitable for use in temporary furnace design or for the heat treatment of pressure vessel welds and sections, or other large fabrications. Heat transfer to the component is effected by combined radiation and convection.

DESIGN

The heater element is manufactured from solid drawn 9swg Kanthal or nickel-chromium coiled wire. The coil may be embedded into a high conductivity cast refractory material within each of the unit stainless channels trays that form the heater. Alternatively the heaters can be manufactured with the traditional ceramic sleeves. The standard heaters are suitable for heat treatment temperatures up to 800°C. Temperatures above this value can be achieved by variation of the composition of the case/coiled wire and heater design. Standard heaters are supplied for a range of voltages up to 240V.

APPLICATION

Standard heaters should deliver a current of 55amps and unit heaters are designed for a range of voltages between 30 and 277V. The higher rating permits the connection of the heaters in groups of three to suit 3-phase supplies.

The heaters may be mounted on to supports (such as shown in the layout which follows) for vessel heat treatments or directly to the components as may be suitable.

Avoid contaminants (grease, paint, oil etc) on the metal surface.

CHANNEL HEATERS

Stock Ref	Description	Width ,mm, Across tails	Length, mm Excluding tails	Volts	kW	Weight, kg
400174	Single Channel	70	400	30	1.65	2.5
400171	Single Channel	70	720	60	3.3	3.9
400158	2-Bank channel	165	720	110	6.6	9.0
400164	4-Bank channel	360	720	60	13.2	15.5
400163	4-Bank channel	360	720	110	13.2	15.5
400152	4-Bank channel	360	720	240	13.2	15.5
400481 to 400490	Element tail extension hot leads c/w 60A male camlok		1m length (Ref 400481), 2m length (Ref 400482), 3m length (Ref 400483) etc, up to 10m length (Ref 400490)			

[RETURN TO MENU](#)

[< BACK](#)

[NEXT >](#)



CHANNEL HEATING ELEMENTS

COMPONENT PARTS

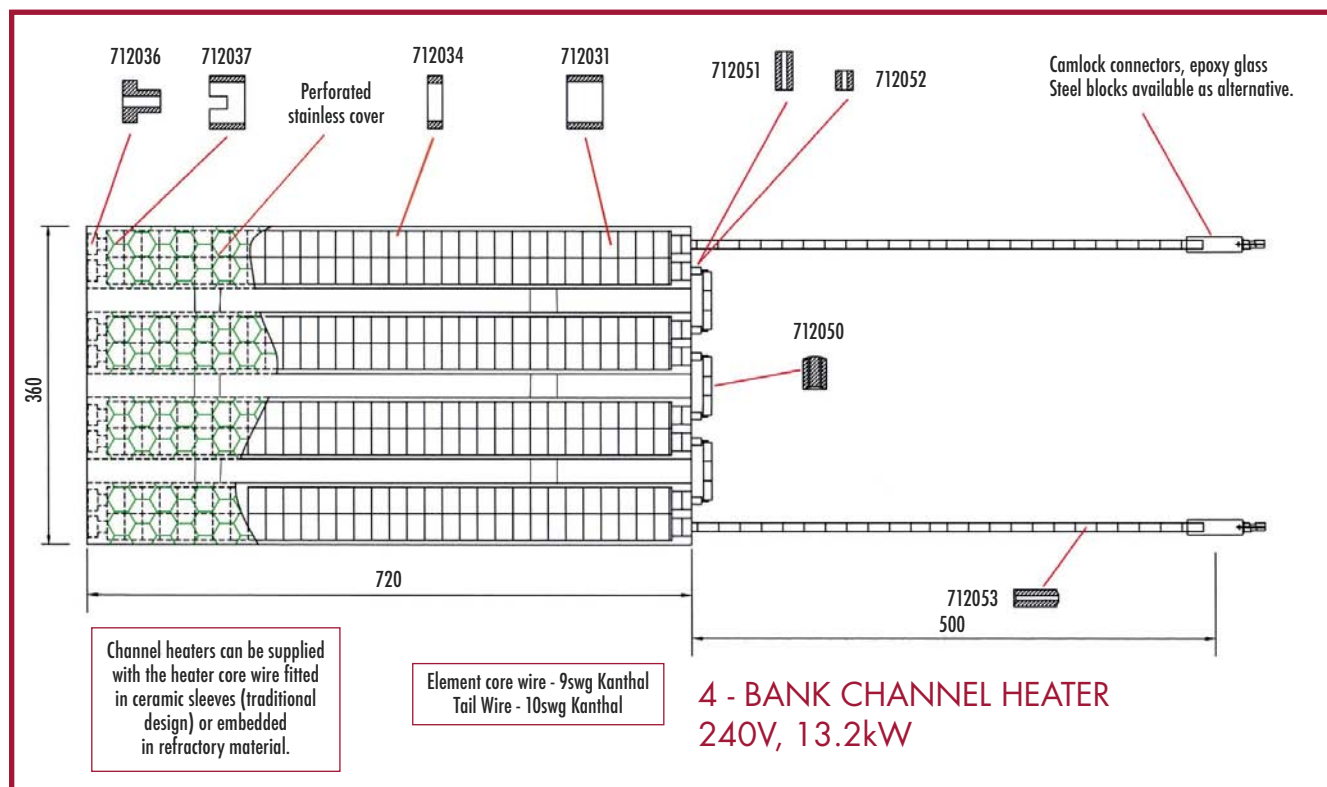

ARRANGEMENTS OF CHANNEL HEATERS FOR PWHT OF CIRCUMFERENTIAL BUTT WELDS IN PRESSURE VESSELS

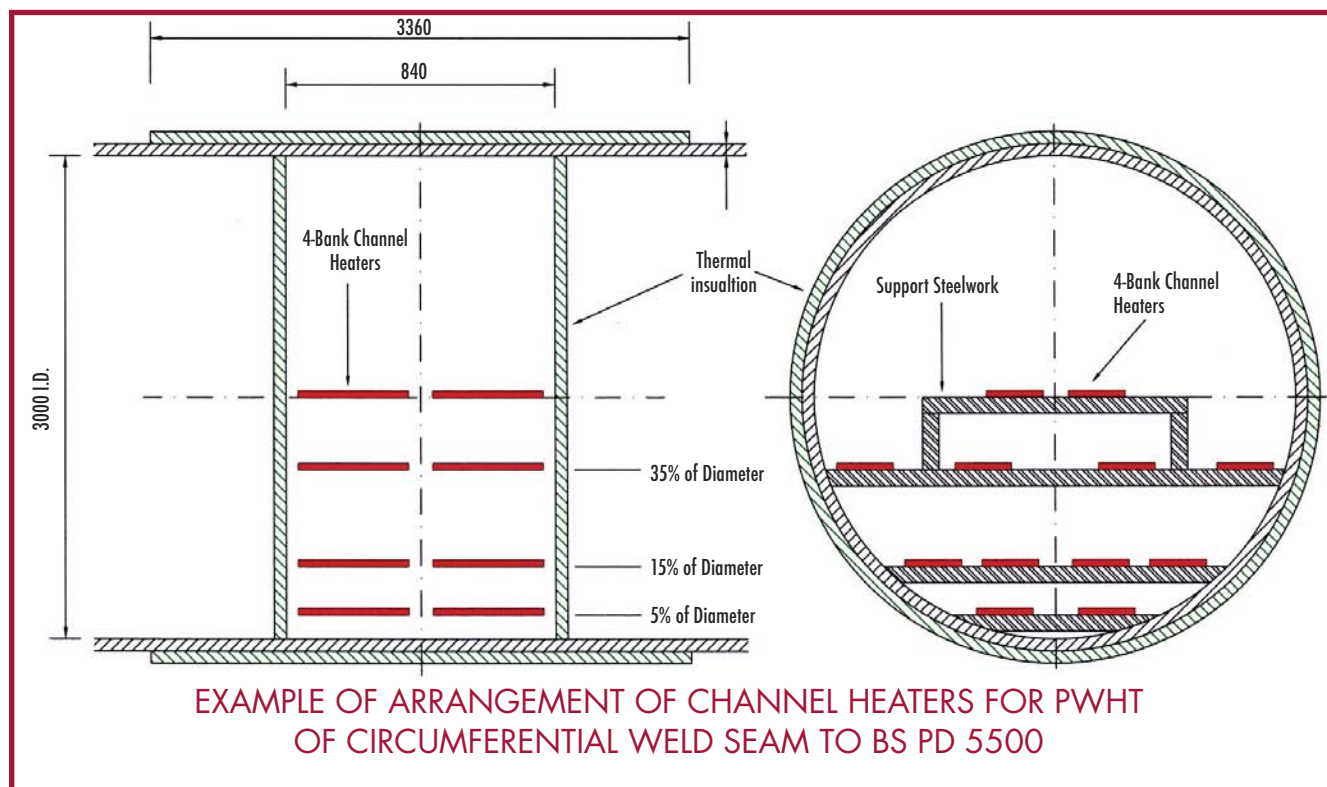

RETURN TO MENU



CERAMIC PAD PREHEATER (CPP) ELEMENTS



Stock Ref. 400181

INTRODUCTION

The ceramic pad preheater element is suitable for preheating and hydrogen diffusion heat treatments associated with the welding process. In view of the flexibility of the heater they may be applied to curved or flat surfaces. They are ideal for the preheating and PWHT of pipework or vessel longitudinal and circumferential weld seams and a wide range of fabricated components

As the design is modular, the heaters can be parallel connected into groups and therefore are suitable for accurate temperature control on a range of applications including vessel circumferential and longitudinal weld seams

APPLICATION

Standard heaters should deliver a current of 45amps. Minimise secondary cable lengths. Check the current delivered. Connect no more than three heaters in parallel to form one circuit.

Fit heater pad securely to component using magnetic fixings or by banding or other suitable means and lock connectors fully home.

Avoid contaminants (grease, paint, oil etc) on the metal surface.

DESIGN

The design of each CPP is based on a ceramic pad element manufactured in sintered high alumina ceramic beads with a nickel-chromium flexible core wire serpentine within the beads. The pads are selected on the basis of their dimensions as is suitable for the preheat temperature range.

The ceramic pad is mounted directly on to a safe Superwool insulation backing which is housed in a stainless steel mesh. The pad/insulation assembly is, in turn, protected with a flexible stainless steel backing. The backing permits the efficient application of the heater to the metal surface using magnetic fixings or by banding.

CERAMIC PAD PREHEATERS

Stock Ref	Width, mm	Length, mm	Volts	kW	Element Stock Ref
400181	101	775	60	2.7	400001
400182	127	604	60	2.7	400002
400189†	620	126	60	2.7	400009
400211	101	1024	80	3.6	400031
400212	127	793	80	3.6	400032
400220†	918	110	80	3.6	400040

Heater tails are across the width of the heater except where marked thus †



Stock Ref. 800092

[RETURN TO MENU](#)

[< BACK](#)

[NEXT >](#)



PREHEATER ELEMENTS – TANK TRACK BEADS



Stock Ref. 400331

DESIGN

The Tank Track Preheater has the same design concept as the ceramic bead CPP in terms of the insulation backing and stainless steel protection. The ceramic pad element is, however, replaced by full width beads, 75mm wide. The heater has an overall width of 101mm.

The construction of the element is simple with a facility to accommodate six longitudinal runs of the heater core wire. The standard heater is rated for 60V or 80V operation using a heat treatment transformer as the power source.

TANKTRACK PREHEATER ELEMENT

Stock Ref	Width,mm	Length, mm	Volts	kW
400331	101	775	60	2.7
400301	101	1024	80	3.6

Heater tails are across the width of the heater.

SUGGESTED HEATED BAND WIDTH FOR WELD PREHEATING USING CPP HEATERS

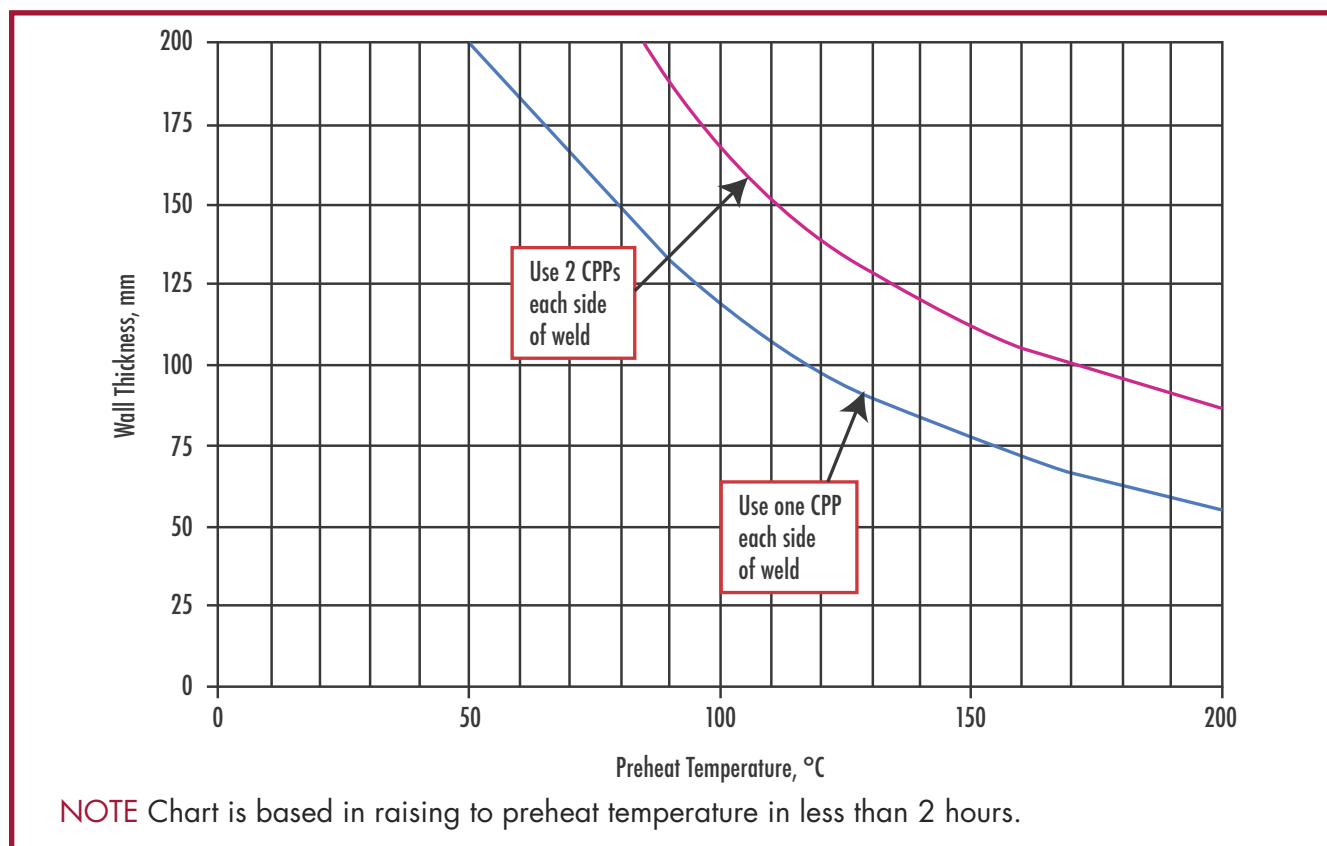

RETURN TO MENU

KEY SPARE PARTS & ACCESSORIES



POWER CABLES

Reference Number	Description
LOW VOLTAGE SYSTEM – power source to splitter cables	
500001	Triple cable set, 16mm ² copper, 135A, 10m long, (c/w compensating lead & connectors)
500002	Triple cable set, 16mm ² copper, 135A, 25m long, (c/w compensating lead & connectors)
500003	Triple cable set, 16mm ² copper, 135A, 30m long, (c/w compensating lead & connectors)
500004	Triple cable set, 25mm ² copper, 185A, 10m long, (c/w compensating lead & connectors)
500005	Triple cable set, 25mm ² copper, 185A, 25m long, (c/w compensating lead & connectors)
500006	Triple cable set, 25mm ² copper, 185A, 30m long, (c/w compensating lead & connectors)
500013	Single power cable, 16mm ² copper, 135A, 30m long, c/w connectors
500016	Single power cable, 25mm ² copper, 185A 30m long, c/w connectors
701270	Double insulated welding cable, 16mm ² , copper, per metre length
701273	Double insulated welding cable, 25mm ² , copper, per metre length
701277	Double insulated welding cable, 35mm ² , copper, per metre length
701281	Double insulated welding cable, 50mm ² , copper, per metre length
LOW VOLTAGE SYSTEM – splitter cables to heaters	
500031	2-way splitter c/w 2x60A female & 1x300A male connectors
500032	3-way splitter c/w 3x60A female & 1x300A male connectors
500033	4-way splitter c/w 4x60A female & 1x300A male connectors
500034	5-way splitter c/w 5x60A female & 1x300A male connectors
500035	6-way splitter c/w 6x60A female & 1x300A male connectors
3-PHASE 380/440V SYSTEM – splitter cables to control unit	
500062	Quadruple cable set c/w camlok connectors (splitters) and 5-pin, 415V plug, (control unit), 30m
3-PHASE 380/440V SYSTEM – heaters to splitter cables	
500070	Star point splitter cable



[RETURN TO MENU](#)

[< BACK](#)

[NEXT >](#)



THERMAL INSULATION

INTRODUCTION

Thermal insulation blanket is available as mats encased in 18/8 stainless steel mesh or in unmeshed rolls. Insulation blankets are supplied in both Superwool 607™ and Ceramic Fibre materials for a range of thicknesses and densities.

Pre-meshed mats can be readily applied to the workpiece for preheat and PWHT processes having the advantage of re-use.

DESCRIPTION

Both Superwool and Ceramic Fibre insulation blankets have outstanding thermal properties at high temperatures. The standard Superwool 607™ and Ceramic Fibre blanket materials have classification temperatures of 1100°C and 1260°C respectively. Both are therefore suitable for preheat and PWHT applications on carbon and low alloy steels, where the heater temperature lies below these values.

An alternative to Superwool 607 material is recommended for exposure temperatures above 1100°C.

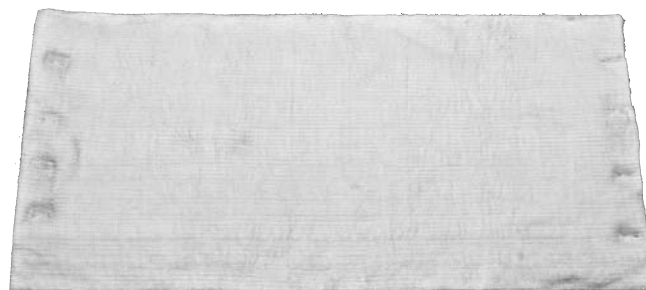

BENEFITS

- The materials offered have outstanding insulation properties. They have low heat storage values and good thermal stability.
- The blankets are produced with no binder or lubricant.
- The blankets have good resistance to tearing, are flexible and immune to thermal shock.
- Superwool 607™ is exonerated from any carcinogenic classification under nota Q of directive 97/69 EC
- The applicable temperature ranges for use are given in the chart opposite.

INSULATION MATS – SELECTED RANGE

Stock Ref Ceramic Fibre	Stock Ref Superwool 607	Length, mm	Width, mm	Thickness, mm	Density, kg/m ³
600070	600121	305	305	25	96
600071	600122	610	305	25	96
600072	600123	915	305	25	96
600081	600131	610	610	25	96
600082	600132	915	610	25	96
600083	600133	1220	610	25	96
600085	600135	1830	610	25	96
600086	600136	2440	610	25	96
600088	600138	3660	610	25	96
600091	600151	305	305	25	128
600092	600152	610	305	25	128
600093	600153	915	305	25	128
600101	600161	610	610	25	128
600102	600162	915	610	25	128
600103	600163	1220	610	25	128
600105	600165	1830	610	25	128
600106	600166	2440	610	25	128
600108	600167	3660	610	25	128

Mats can be supplied in 305 and 610mm widths and lengths up to 7200mm.

[RETURN TO MENU](#)

THERMAL INSULATION - UNMESHED



UNMESHED INSULATION ROLLS

Stock Ref	W, mm	L, mm	T, mm	Density kg/m ³	Insulation Type
600020	610	7320	25	96	Superwool 607
600021	610	7320	25	128	Superwool 607
600022	610	7320	50	96	Superwool 607
600023	610	7320	50	128	Superwool 607
600005	610	7320	25	96	Ceramic Fibre
600006	610	7320	50	96	Ceramic Fibre
600010	610	7320	25	128	Ceramic Fibre
600011	610	7320	50	128	Ceramic Fibre

TEMPERATURE RANGE FOR USE OF SUPERWOOL 607™

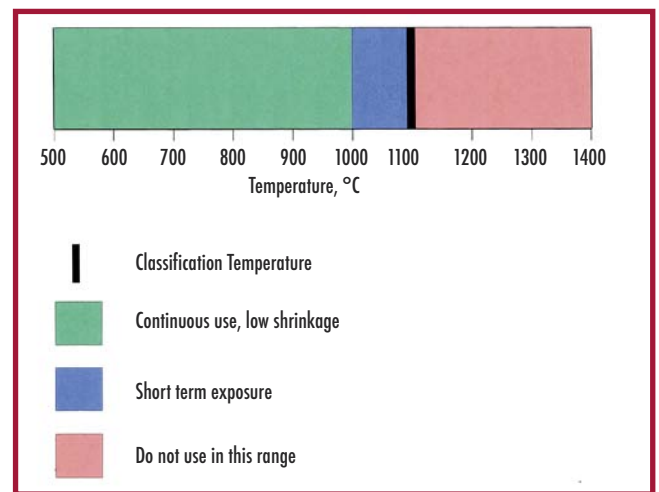

THERMAL CONDUCTIVITY OF SUPERWOOL 607™ INSULATION

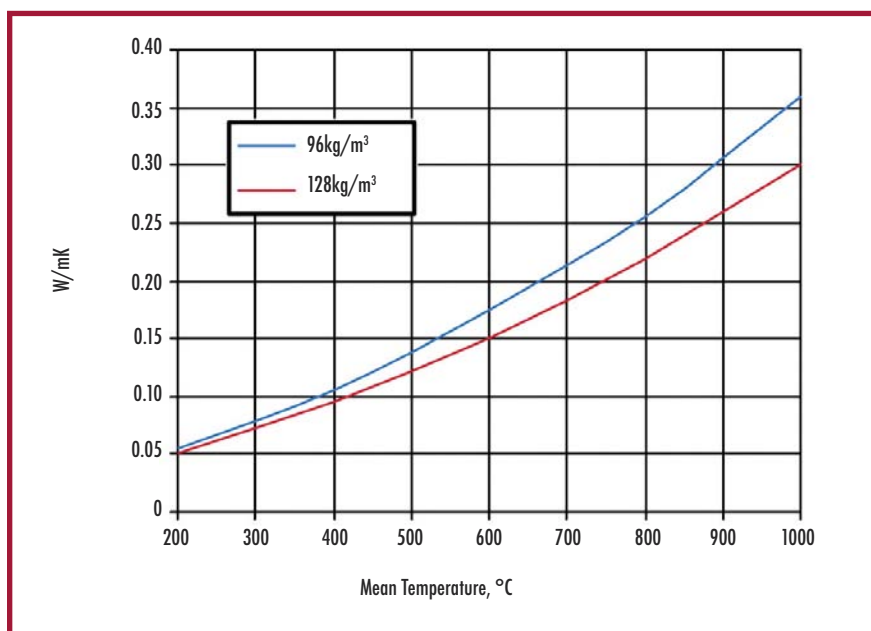

[RETURN TO MENU](#)

[< BACK](#)

[NEXT >](#)

KEY SPARE PARTS & ACCESSORIES



HEAT TREATMENT TRANSFORMERS

Reference Number	Description
TRANSFORMER	
700001	Transformer core and windings, 50-kVA unit. Primary voltage 380/415/440V, 3 phase.
700031	Transformer core and windings, 65-kVA unit. Primary voltage 380/415/440V, 3 phase.
702821	Fan guard
702804	160mm dia axial fan
703031	Capacitor for shunt trip.
711002	Spare nylon swivel wheel (160mm dia)
711001	Spare nylon (fixed) wheel 160mm dia)
703050	Over temperature thermostat for 50 kVA unit
SWITCHES, CONTACTS etc	
702420	100A MCCB for 50 kVA unit
702421	160A MCCB for 65 kVA unit
702425	Shunt trip
702001	Channel indicator neon
702201	Single pole 200A contactor, 110V a.c. for transformer units
702321	Fixed and moving contacts for 200A contactor.
702401	Auto/manual switch for transformer units
CONNECTORS	
705052	300A female panel mounted camlok connector
705232	Panel mounted thermocouple socket
705131	Panel mounted multi pin plug on transformer for control
705082	110 a.c. panel mounted outlet
702002	110V channel indicator lamp (green)
CONTROL	
700231	PID digital temperature controller, 0-1000°C
700250	115V a.c. energy regulator
700251	Dial for energy regulator
700252	Knob for energy regulator
702631	Panel mounted fuse holder



702420



702804



705232



705052



702201



702321



705131



705082



700250

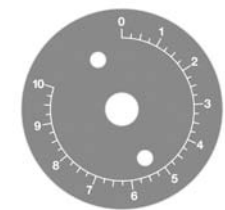

700251

[RETURN TO MENU](#)

KEY SPARE PARTS & ACCESSORIES



SPARES FOR PROGRAMMER UNIT

Reference Number	Description
701291	110V a.c supply cable, 3-core, per metre
701402	Cable gland (110V, 3-core)
705061	3-pin in-line plug for power supply
700201	Ramp generator for P256 Programmer
705126	Multi pin control socket for connection to power source
705232	Panel mounted thermocouple socket
702001	Red indicator lamps
702002	Green indicator lamps
702003	Amber indicator lamps
701316	7-core type YY control cable



INSULATION SPARES & ACCESSORIES

Reference Number	Description
600005	Ceramic fibre unmeshed roll, 610x7320x25mm, 96 kg/m ³
600010	Ceramic fibre unmeshed roll, 610x7320x25mm, 128 kg/m ³
600020	Superwool 607 unmeshed roll, 610x7320x25mm, 96 kg/m ³
600021	Superwool 607 unmeshed roll, 610x7320x25mm, 128 kg/m ³
800001	Roll stainless steel mesh for insulation mat, 100mm wide, 10 kg/roll
800002	Roll stainless steel mesh for insulation mat, 127mm wide, 10 kg/roll
800003	Roll stainless steel mesh for insulation mat, 330mm wide, 15 kg/roll
800004	Roll stainless steel mesh for insulation mat, 635mm wide, 25 kg/roll



[RETURN TO MENU](#)

[< BACK](#)

[NEXT >](#)

KEY SPARE PARTS & ACCESSORIES



TEMPERATURE RECORDING EQUIPMENT

Reference Number	Description
700401	Chino EH100 recorder 180mm chart (fan fold), 0-1200°C
730403	Chino EH100 ink dotting wheel
730401	Chino EH100 inks (12 colour)
800159	Temperature recorder check calibration instrument
800061	Type K thermocouple conductor wire, twin twisted, 0.711mm. For spark discharge welding, 100m
800031	Thermocouple putty for hot junction, 0.5 kg
705201	Standard in-line thermocouple plug
705231	Standard in-line thermocouple socket
705210	Quick-fit in-line thermocouple plug - yellow
705240	Quick-fit in-line thermocouple plug - yellow
705232	Standard panel mounted thermocouple socket,
701351	Reel, compensating lead for Type K thermocouple, 100m lengths

Compensating cable is also available in lengths of 300m and 500m

500091	Compensating cable for Type K thermocouple, 30m long c/w 1 in-line plug and 1 in-line socket
500093	Compensating lead for Type K thermocouple, 10m long c/w 1 in-line plug and 1 in-line socket
500095	Compensating lead for Type K thermocouple, 1m long c/w 1 in-line plug at each end (jumper cable)
800170	Digital temperature indicator c/w probe for operating temperature range for Type K thermocouples
800175	Magnetic temperature indicator, 0-400°C
800071	Stainless steel sheathed thermocouple, mineral insulated, 600mm long, 3mm dia c/w plug

Stainless steel sheathed thermocouples are available in other lengths



800159



800031



800061



705201



705232



705240



701351



500091



800071



800170

[RETURN TO MENU](#)

KEY SPARE PARTS & ACCESSORIES



CABLE CONNECTORS

Reference Number	Description
CAMLOK CONNECTORS	
705042	60A male, in-line, complete, standard sleeve
705043	60A male, in-line, complete, epoxy sleeve
705047	60A female, in-line, complete, standard sleeve
705048	60A female, in-line, complete, epoxy sleeve
705032	300A male, in-line, complete, standard sleeve
705033	300A male, in-line, complete, epoxy sleeve
705037	300A female, in-line, complete, standard sleeve
705038	300A female, in-line, complete, epoxy sleeve
705007	Brass section for in-line 60A male camlok
705008	Brass section for in-line 60A female camlok
705001	Brass section for in-line 300A male camlok
705002	Brass section for in-line 300A female camlok
705019	Insulated sleeve for in-line male 60A camlok, standard
705020	Insulated sleeve for in-line female 60A camlok, standard
705021	Insulated sleeve for in-line male 60A camlok, epoxy
705022	Insulated sleeve for in-line female 60A camlok, epoxy
705013	Insulated sleeve for in-line male 300A camlok, standard
705014	Insulated sleeve for in-line female 300A camlok, standard
705015	Insulated sleeve for in-line male 300A camlok, epoxy
705016	Insulated sleeve for in-line female 300A camlok, epoxy
705028	Fibre pin for 60A camlok
705025	Fibre pin for 300A camlok
705052	300A Female panel mounted camlok connector
705053	60A Female panel mounted camlok connector
705057	300A Male panel mounted camlok connector
705058	60A Male panel mounted camlok connector
110V CONNECTORS	
705061	110V, 16A, 110V 3-pin in-line plug
MAINS CONNECTOR PLUG/SOCKET	
705091	415V 3-phase 63A 5-pin in-line plug
705111	415V 3-phase 63A 5-pin panel mounted socket.



[RETURN TO MENU](#)

[← BACK](#)

[NEXT →](#)

KEY SPARE PARTS & ACCESSORIES



CERAMIC PAD ELEMENTS

Reference Number	Description
712001	Main body bead, pink
712002	Main body bead with hole, pink
712003	Female end bead, pink
712004	Female end bead with hole, pink
712005	Male end bead, pink
712006	Male end bead with hole, pink
712007	Main body bead, white
712008	Main body bead with hole, white
712013	Small single hole tail bead, white
712014	Small single hole tail bead, pink
712053	Large single hole tail bead, pink
701601	Heater core wire, 80/20, (19 strand), 0.29Ω/m
701603	Heater core wire, 60/16, (19 strand), 0.28Ω/m
701631	7 strand cold tail, nickel 212
705042	60A, male camlok connector complete
705019	60A, male camlok connector - sleeve
705028	60A, male camlok connector - pin
704830	Mild steel welding ferrule for tail junction, 6mm dia x 25mm long
704831	Stainless steel crimping ferrule for tail junction, 6mm dia x 13mm long



CERAMIC PAD PREHEATERS

Reference Number	Description
724032	Superwool 607 meshed insulation mat for preheater element 400181, 101x775x25mm
724076	Superwool 607 meshed insulation mat for preheater element 400182, 127x610x25mm
724040	Superwool 607 meshed insulation mat for preheater element 400189, 620x126x25mm
720201	Stainless steel backing for ceramic pad element 400181, 101x75mm
720202	Stainless steel backing for ceramic pad element 400182, 127x604mm
720210	Stainless steel backing for ceramic pad element 400189, 620x126mm
800092	Round magnet fixing assy c/w strap
800106	Round magnet
800115	Straight strap
708225	S/steel split pins for backing
707201	S/steel flat washers for backing

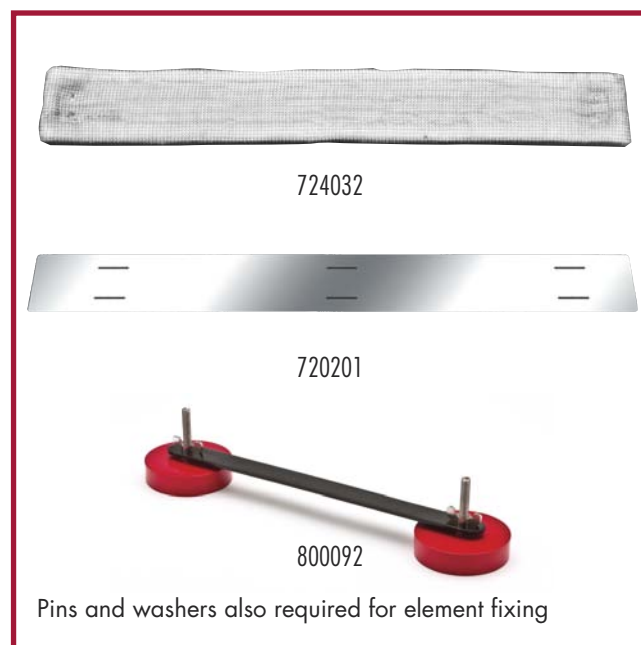

[RETURN TO MENU](#)

KEY SPARE PARTS & ACCESSORIES



TANK TRACK PREHEAT ELEMENTS

Reference Number	Description
712017	Tank track bead, plain, pink
712018	Tank track bead single centre hole, pink
712019	Tank track bead double hole, 25mm centres, pink
712020	Tank track bead double hole, 50mm centres, pink
720231	Stainless steel backing for tank track element 400241, 101x775mm
720232	Stainless steel backing for tank track element 400255, 101x1024mm
724032	Superwool 607 meshed insulation mat for preheater tank track element 400341, 101x775x25mm
708225	S/steel split pins for backing
707201	S/steel flat washers for backing



CHANNEL HEATING ELEMENTS

Reference Number	Description
712031	Main body bead, full size
712032	Main body bead, 3/4 size
712033	Main body bead, 1/2 size
712034	Main body bead, 1/4 size
712036	'Top Hat' end bead
712037	Square slotted bead
712038	Radiused slotted bead
712050	Twin hole bead
712051	Large tube bead - 22mm long
712052	Small tube bead - 13mm long
712053	Large tail bead
701694	Spare coil for 60V single channel heater 400171 c/w tail wire
720351	Spare s/steel channel for 60V single channel heater 400171, c/w perforated retainer
704825	Plated mild steel connection block 2 hole
705042	60A male insulated camlok connector



[RETURN TO MENU](#)

[< BACK](#)

[NEXT >](#)

KEY SPARE PARTS & ACCESSORIES



GENERAL SPARES

Reference Number	Description
HEATER/INSULATION BANDING & SECURING	
800121	Soft iron wire for heater/insulation fixing, 20kg
800125	Mild steel banding tape for securing heaters/insulation, 12mm x 300m
800131	Mild steel buckle clips for item 800125, Qu. 100
800128	Stainless steel banding tape for securing heaters/insulation, 12mm x 30m
800133	Stainless steel buckle clips for item 800125, Qu. 100
800135	Standard banding machine for 800125 and 800128
800136	Ratchet banding machine for 800125 and 800128
800146	Adjustable stainless steel strap c/w screw lock, 1m long
800148	Hooked elastic straps for heater location etc.
800092	Pair of round magnets c/w straight strap

Individual magnets and straps also available

MEASUREMENT

800151	Clamp-on ammeter, complete with multimeter facility
800170	Digital surface temperature indicator c/w probe
800175	Magnetic surface temperature indicator, 0-400°C
800182	Tele-Brineller hardness testing unit
800200	Spare reference bars for Tele-Brineller testing unit
Specify required hardness range for hardness reference bars	
800181	Poldi hardness testing unit.
800190	Reference bars for Poldi hardness testing unit

OTHER ITEMS

704817	10A PVC connector strip
800217	PVC tape; assorted colours

Other tape colours available – specify



RETURN TO MENU

- **Electrical Resistance Heating**
- **High Velocity Gas / Oil Heating**
- **Furnace Manufacture and Contract Services**



Delta Heat Services

Specialist in Heat Treatment

Delta Heat Services B.V.

Scheelhoekweg 2

3251 LZ Stellendam - The Netherlands

PO Box 52

3250 AB Stellendam - The Netherlands

t: +31 (0)187 - 49 69 40

f: +31 (0)187 - 49 68 40

e: info@delta-heat-services.nl

www.delta-heat-services.com